

Touché: Enhancing Touch Interaction on Humans, Screens, Liquids, and Everyday Objects

Munehiko Sato, Ivan Poupyrev, Chris Harrison

CHI 2012, May 5-10, 2012, Austin Texas, USA

Chinmay Parab
Interaction Design

Humans, Screens, Liquids, and Everyday Objects

A photograph of Steve Jobs, co-founder of Apple, holding an iPhone. He is wearing his signature black turtleneck and glasses. The background is dark with a large, glowing white Apple logo. The year '2007' is overlaid in large white text.

2007

Touché: Enhancing Touch Interaction on
Humans, Screens, Liquids, and Everyday Objects

Chinmay Parab
Interaction Design



2012 1.3 Billion
2013 1.8 Billion
2016 2.8 Billion

sliding our fingertips on a glass slab!

Everyday Objects

pencils, tables, chairs, doors, door knobs, mobile phones, etc

Everything is Capacitive, almost everything!

**Touché is an add-on that can sense the change in capacitance
and convert that info into machine language**

How it looks?

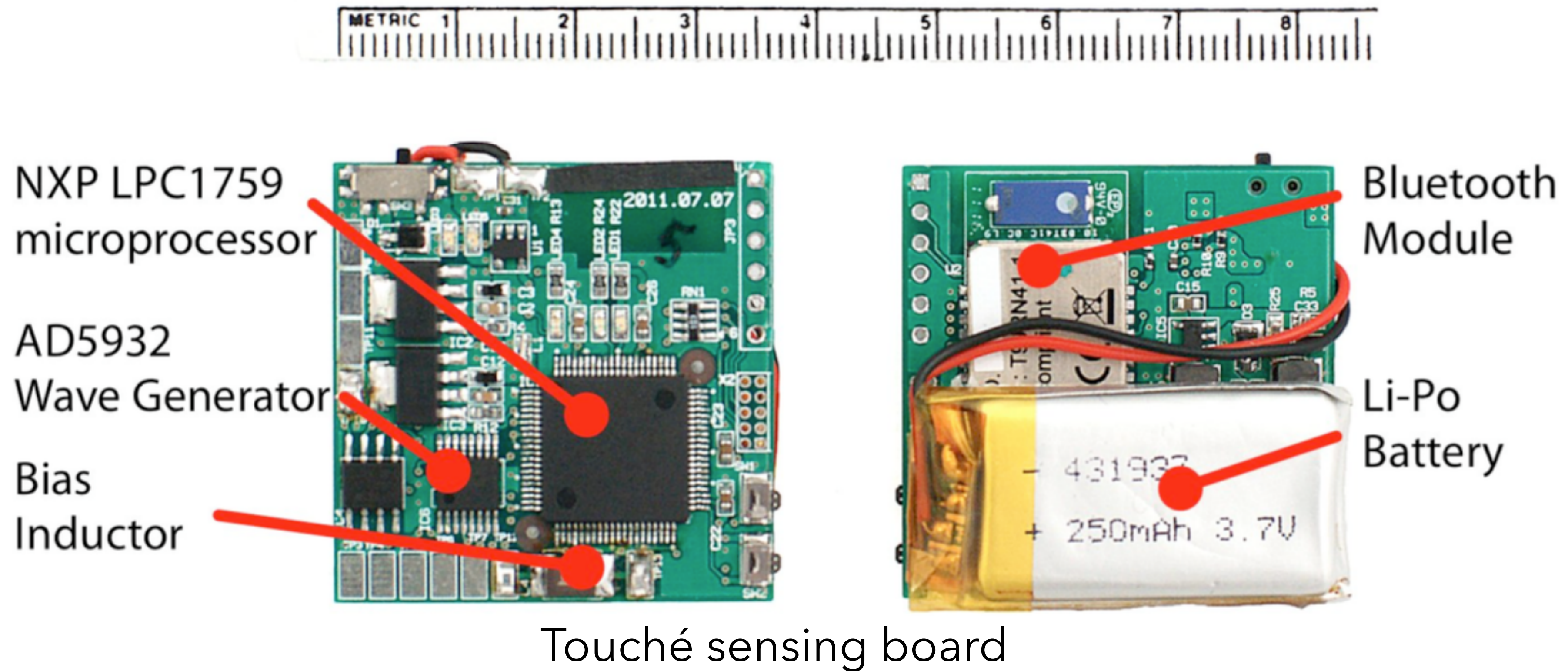

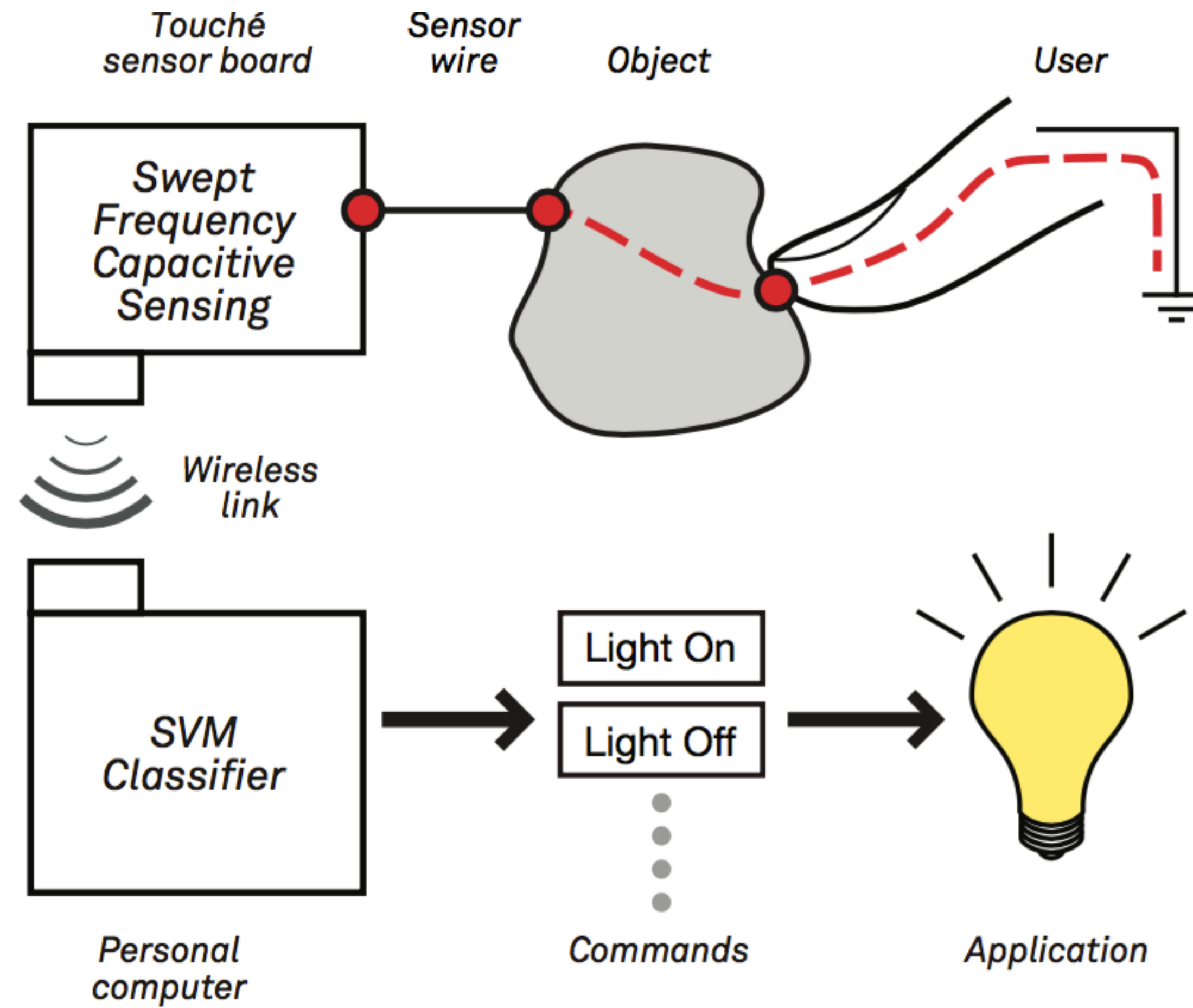

How it works?

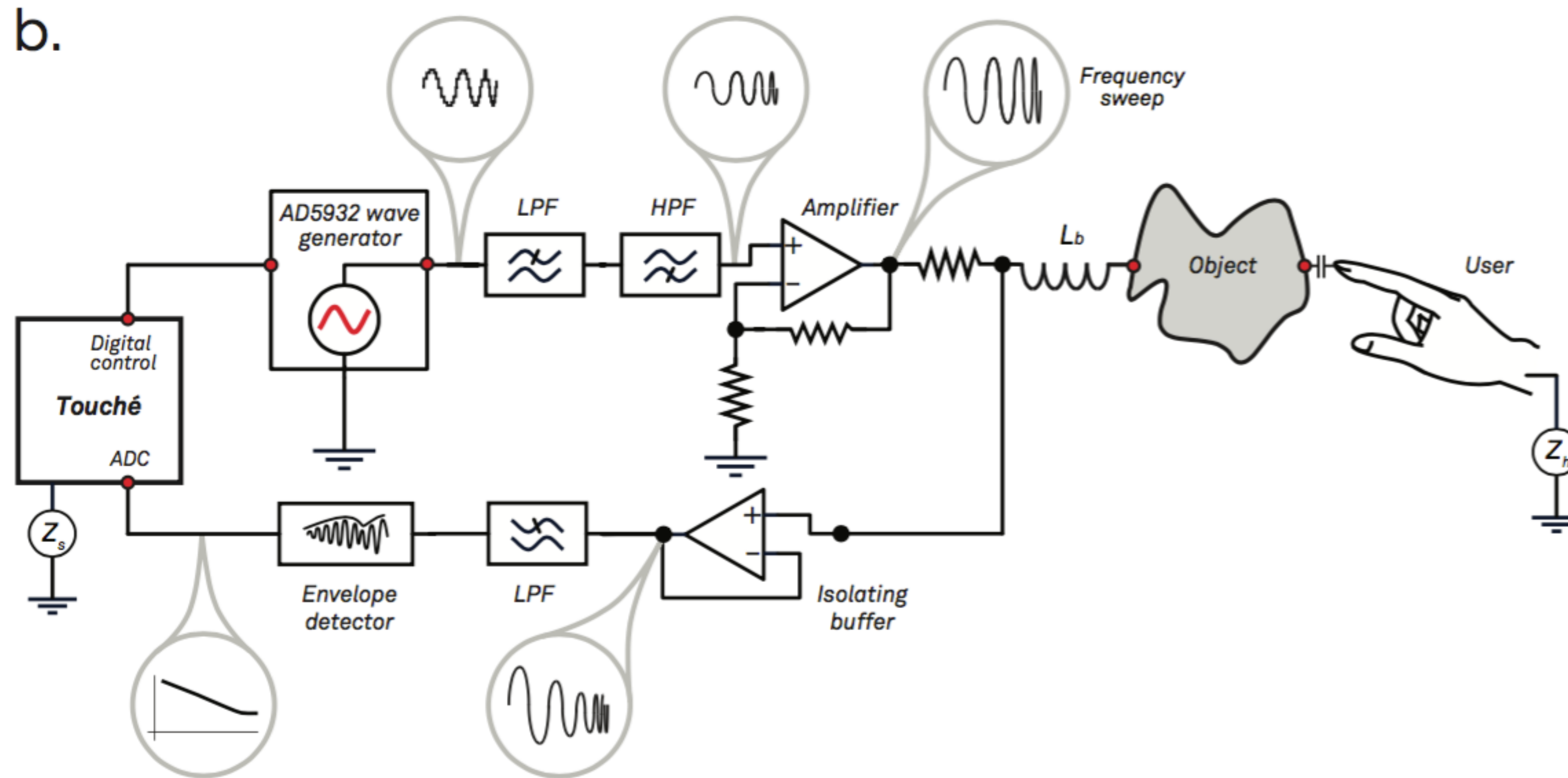

Details?

What it does?

- **Converts any object into Touch enabled interface**
- **Single electrode > Sensor > Controller**
- **Swept Frequency Capacitive Sensing Technique (SFCS)**
- **Provides unique contexts to touch**
- **Variety of Materials**
- **Works on digital as well as analog objects**

Not only if the action occurred, but also how it occurred!

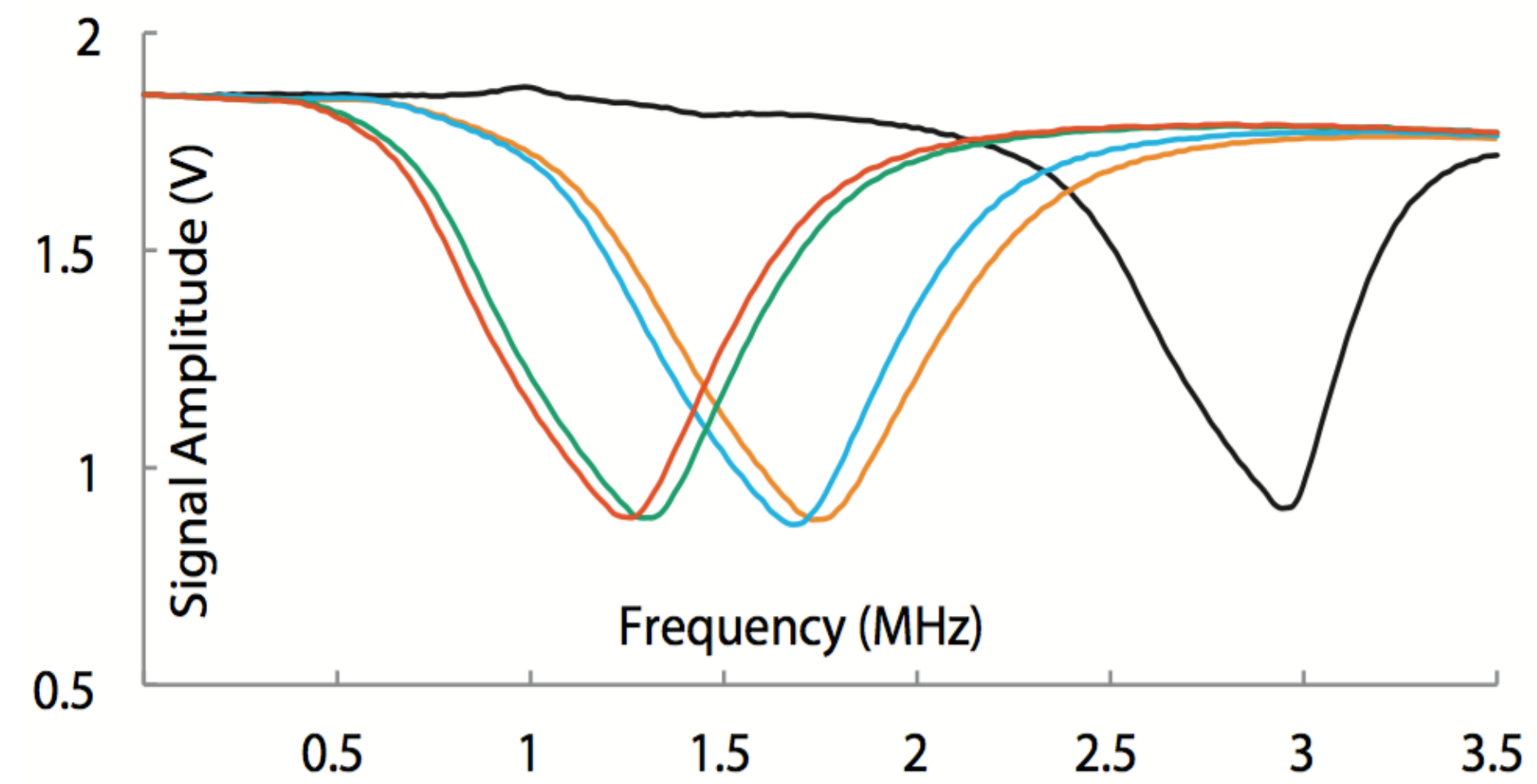
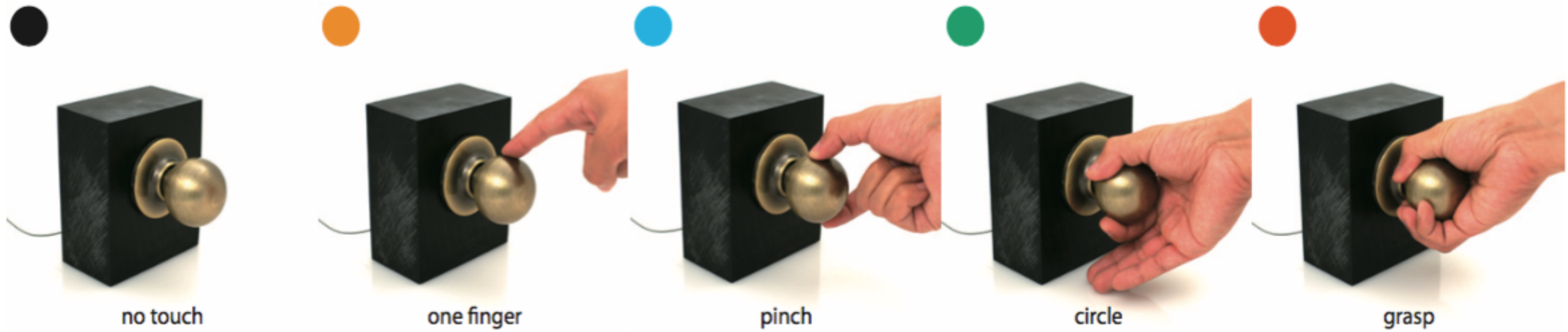

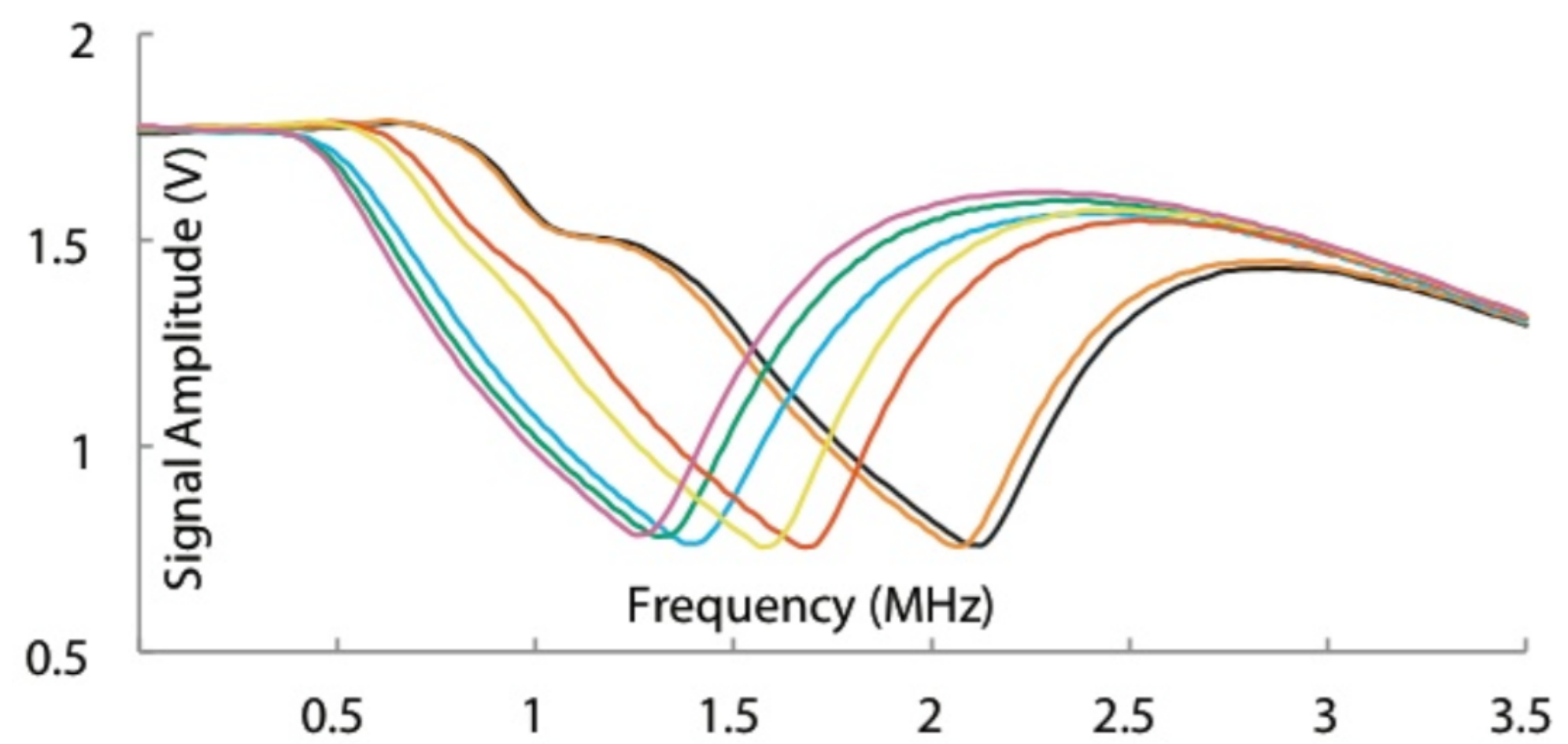
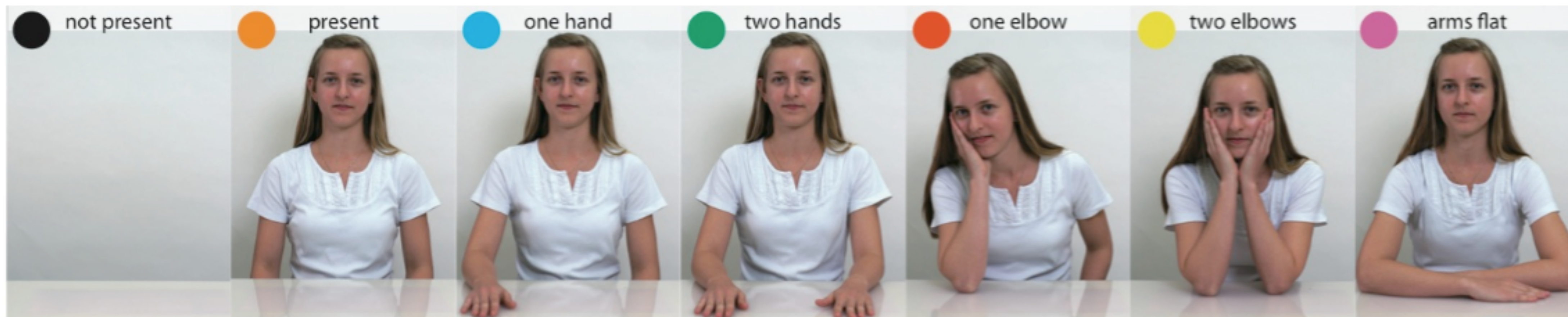

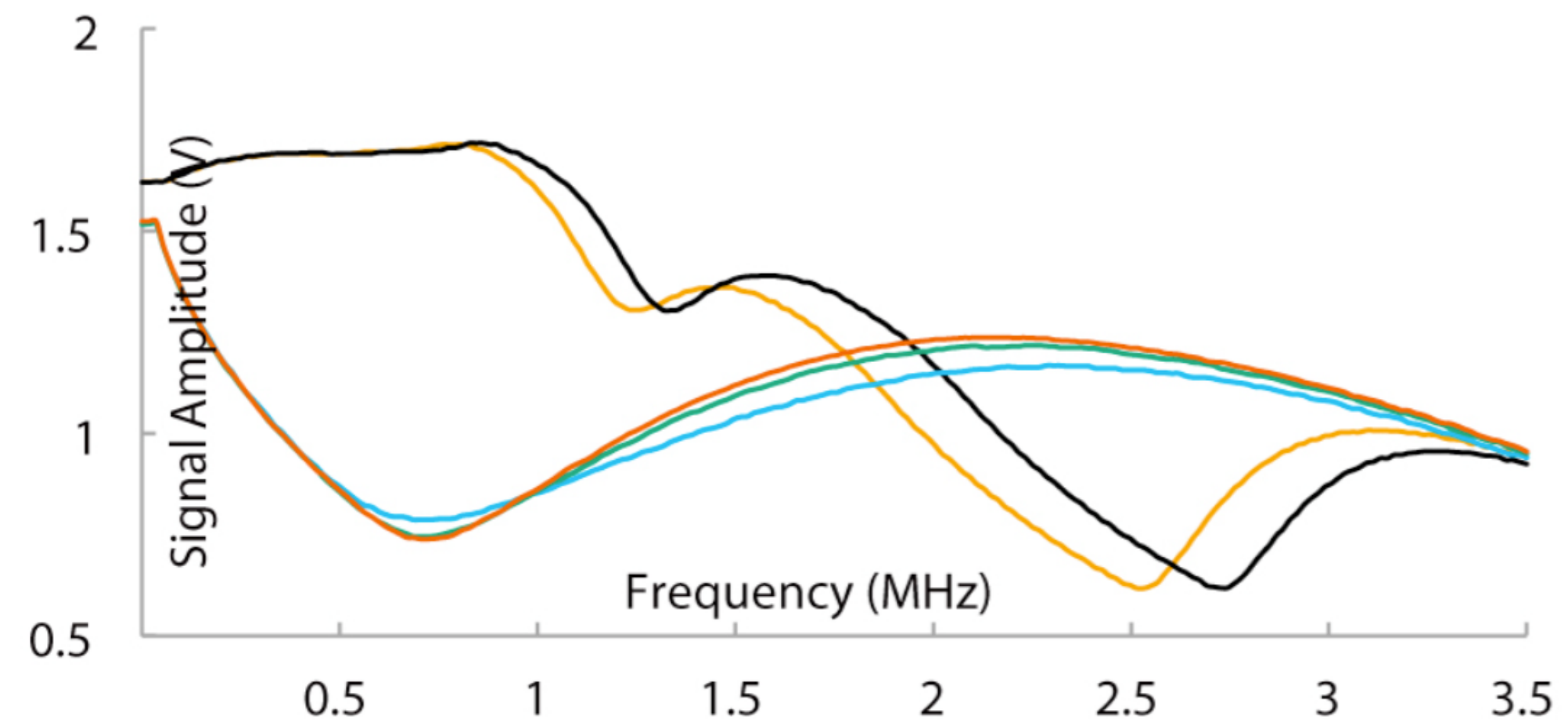

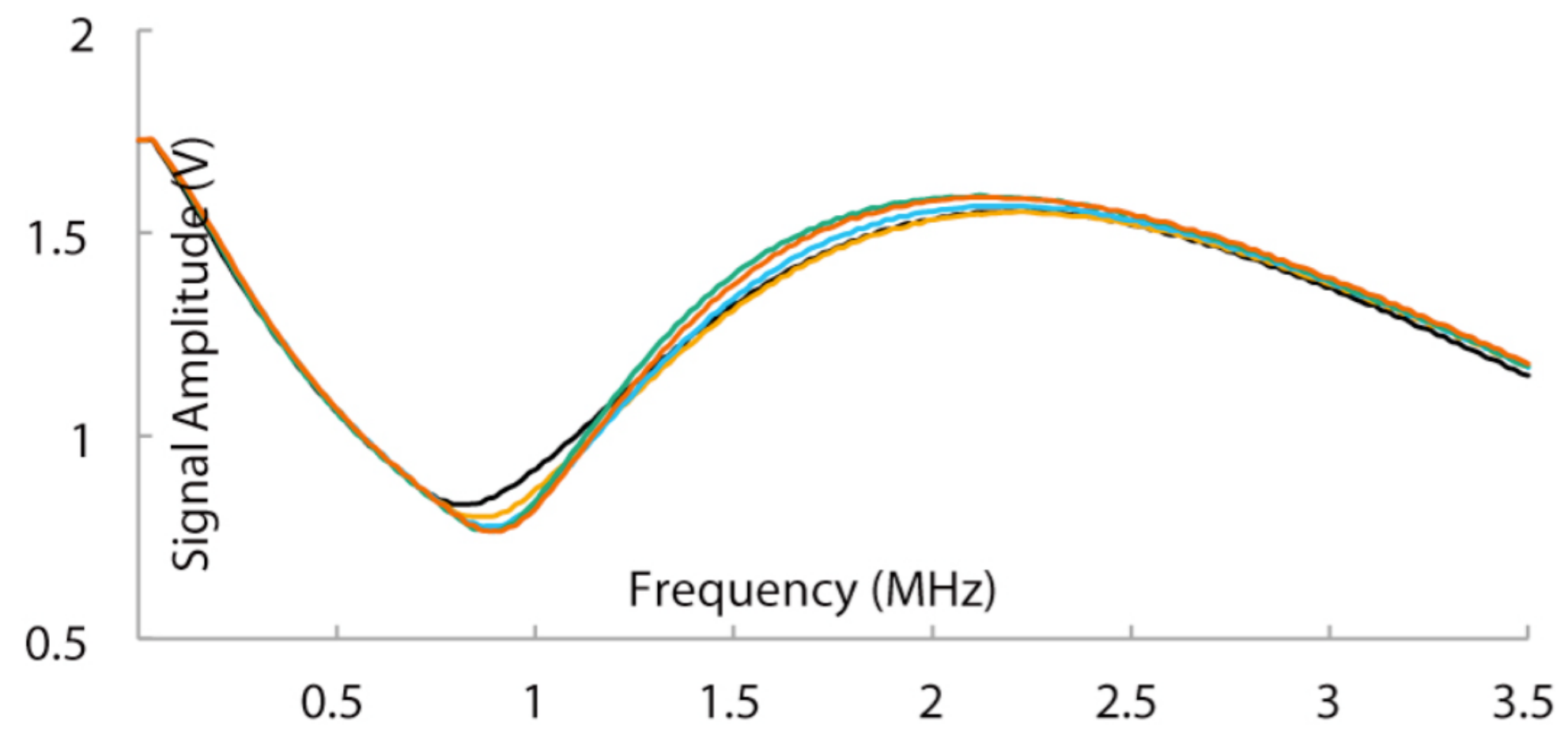

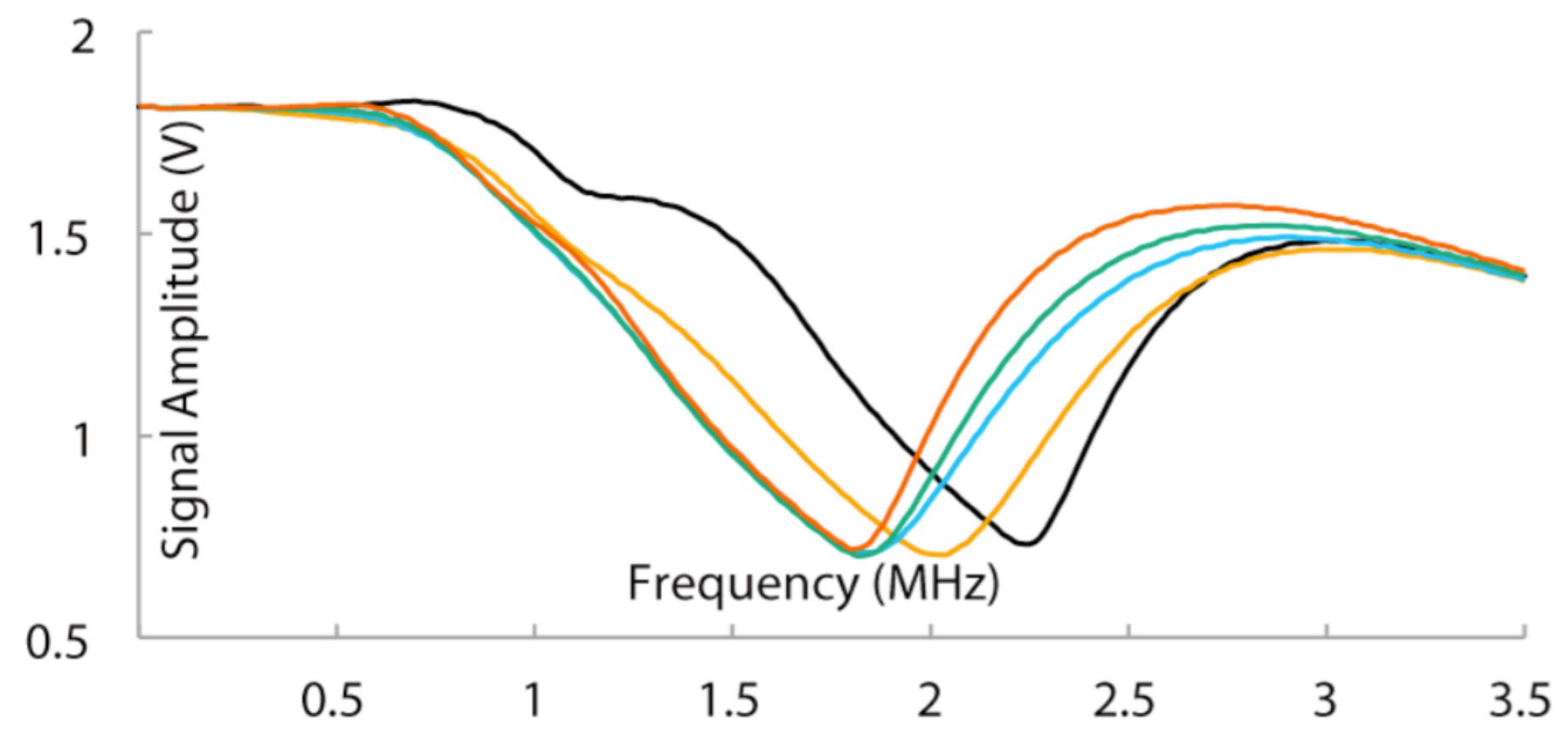
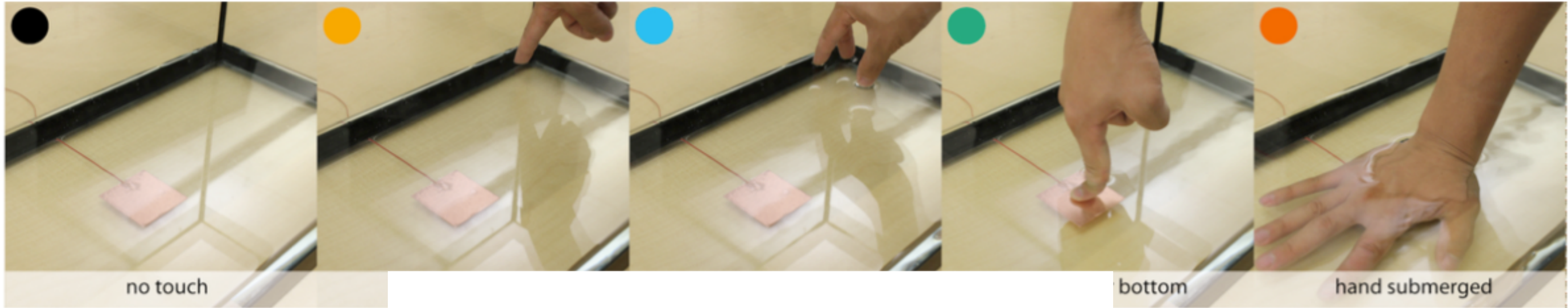

Evaluation goals

- **Demonstrate possibilities**
- **Immediate Feasibility**
- **Explore potential richness of gesture library**
- **Baseline performance of Recognition Engine**
- **System level adaptability for user interactions**

Evaluation process

- **Designed specifically to test system's accuracy: this is to minimise the potential for ceiling effect**
- **Gesture sets for all 5 domains: All gestures and N-1 Gestures**
- **Two groups of 12 participants each**
- **Evaluation training followed by test of 60 min for 7 days**
- **First group of 12 participants were given studies for 1 to 4 domains with solid objects**
- **Second group of 12 participants were given liquid study**

Evaluation Results

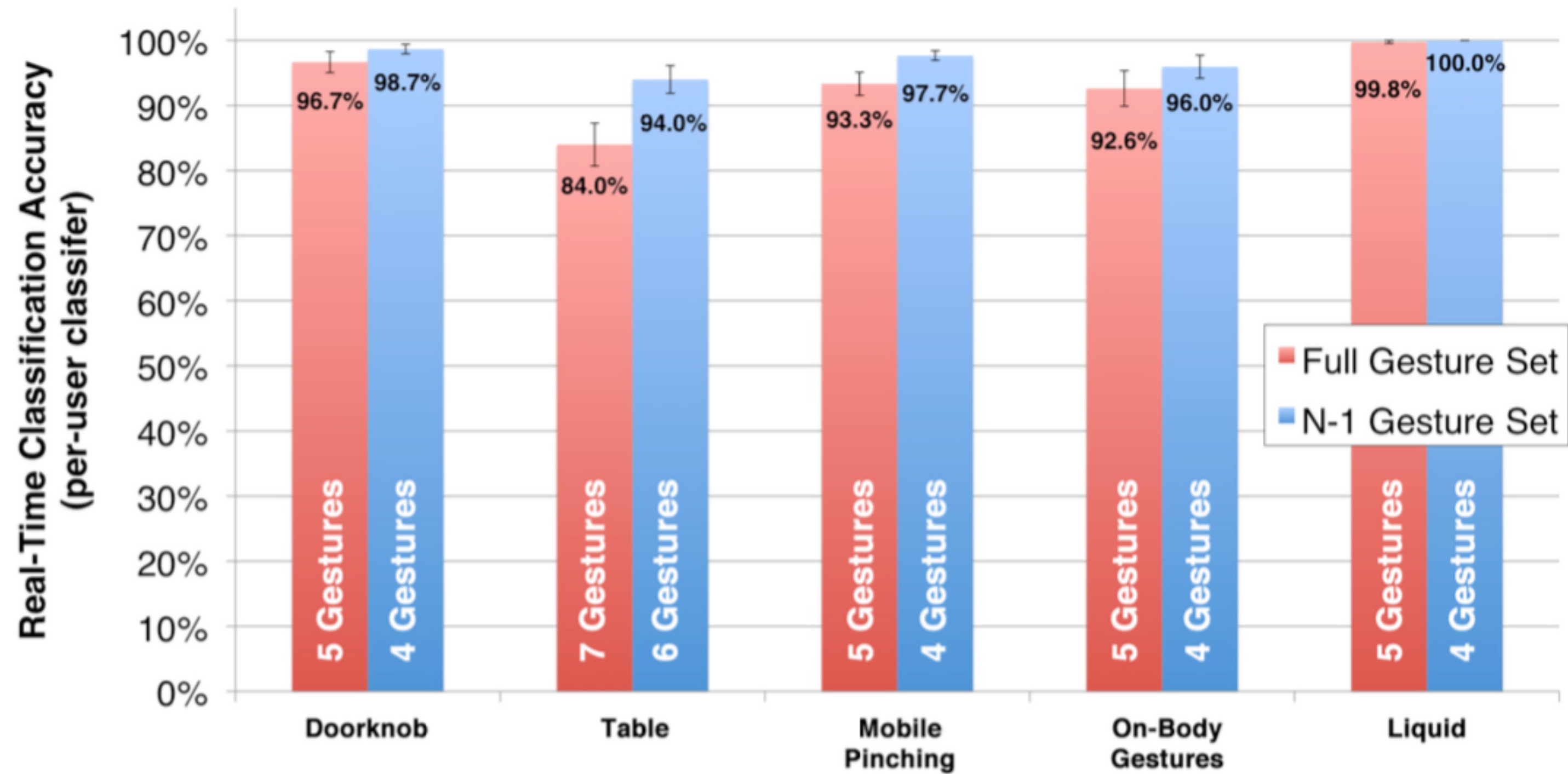

Real-time, per-user classification accuracy for five example application

Evaluation Results

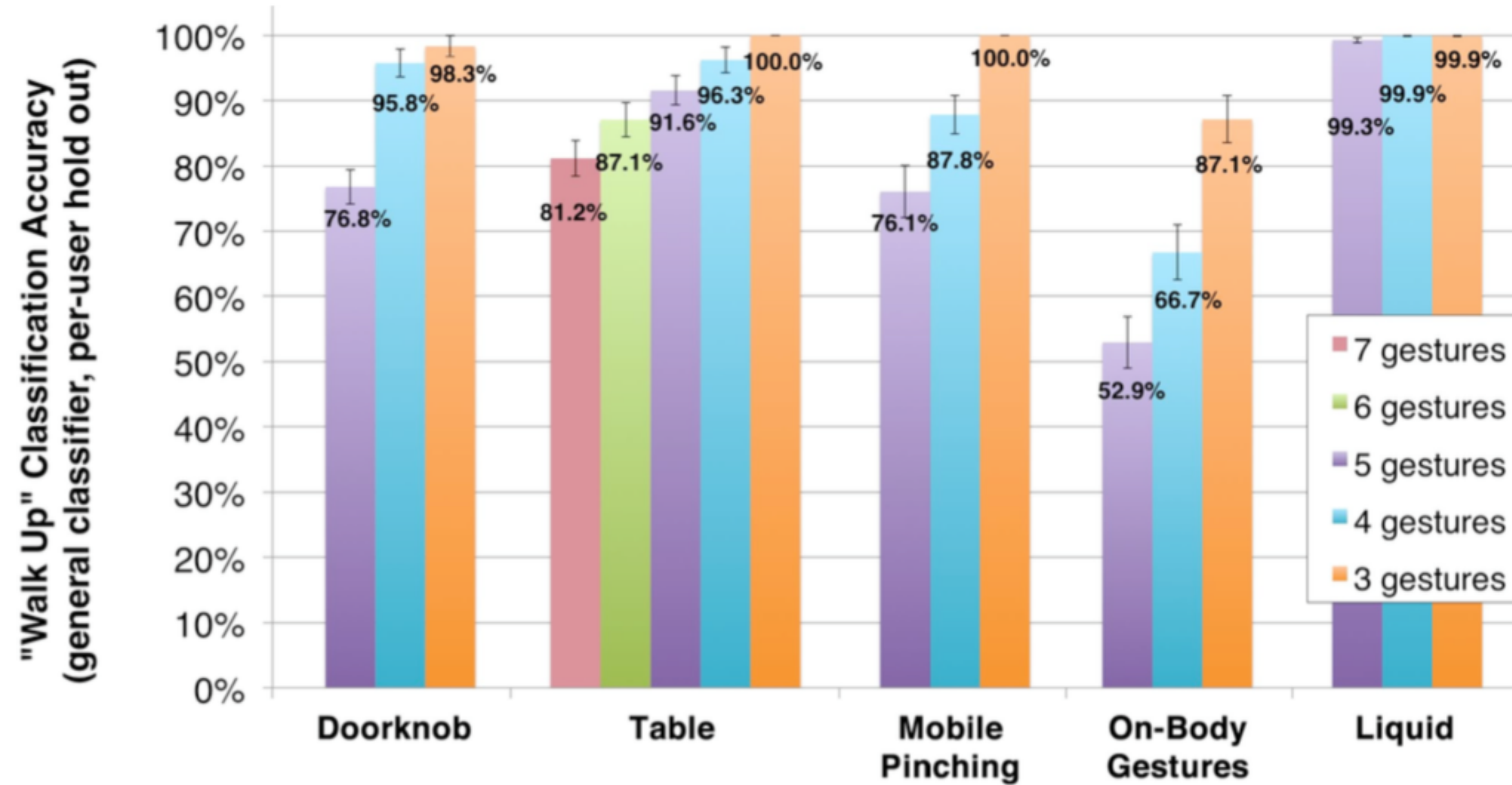

Walk up classification accuracy for five example applications.

Thank you!